

324D L

Hydraulic Excavator



Engine		
Engine Model	Cat® C7 with ACERT™ Technology	
Net Flywheel Power	140 kW	188 hp
Weights		
Operating Weight – Minimum	23 860 kg	52,602 lb
<ul style="list-style-type: none"> • Base Machine, Reach Boom, R2.5CB1 (8 ft 2 in) Stick, 0.63 m³ (0.82 yd³) Bucket, 600 mm (24 in) Shoes. 		

Operating Weight	24 790 kg	54,660 lb
<ul style="list-style-type: none"> • Base Machine, Reach Boom, R2.95CB1 (9 ft 8 in) Stick, 1.1 m³ (1.44 yd³) Bucket, 800 mm (32 in) Shoes. 		
Operating Weight – Maximum	26 250 kg	57,871 lb
<ul style="list-style-type: none"> • Base Machine, Mass Boom, M2.5DB (8 ft 2 in) Stick, 2.34 m³ (3.06 yd³) Bucket, 800 mm (32 in) Shoes. 		

NOTE – The above configurations do not include any optional attachments.

324D L Hydraulic Excavator

The D Series incorporates innovations for improved performance and versatility.

C7 with ACERT™ Technology

- ✓ ACERT™ Technology works at the point of combustion to optimize engine performance and provide low exhaust emissions to meet U.S. EPA Tier 3 emission regulations, with exceptional performance capabilities and proven reliability. **pg. 4**

Versatility

Caterpillar offers a wide variety of factory-installed attachments that enhance performance and job site management. **pg. 11**

Hydraulics

The hydraulic system has been designed to provide reliability and outstanding controllability. An optional Tool Control System provides enhanced flexibility. **pg. 5**

Service and Maintenance

Fast, easy service has been designed in with extended service intervals, advanced filtration, convenient filter access and user-friendly electronic diagnostics for increased productivity and reduced maintenance costs. **pg. 12**

Operator Comfort

- ✓ Provides maximum space, wider visibility and easy access to switches. The monitor is a full-color graphical display that allows the operator to understand the machine information easily. Overall, the new cab provides a comfortable environment for the operator. **pg. 6**



Structures

Caterpillar® design and manufacturing techniques assure outstanding durability and service life from these important components. **pg. 8**

Booms, Sticks and Bucket Linkages

Three lengths of booms and five sticks are available, offering a range of configurations suitable for a wide variety of application conditions. The bucket linkage pins have been enlarged to improve reliability and durability. All Booms and Sticks are stress relieved. **pg. 9**

Work Tools – Attachments

- ✓ A variety of work tools, including buckets, couplers, hammers, and shears are available through Cat Work Tools. **pg. 10**

Complete Customer Support

Your Cat® dealer offers a wide range of services that can be set up under a customer support agreement when you purchase your equipment. The dealer will help you choose a plan that can cover everything from machine configuration to eventual replacement. **pg. 13**



✓ *New Feature*

C7 with ACERT™ Technology

The Cat® C7 gives the 324D exceptional power and fuel efficiency unmatched in the industry for consistently high performance in all applications.

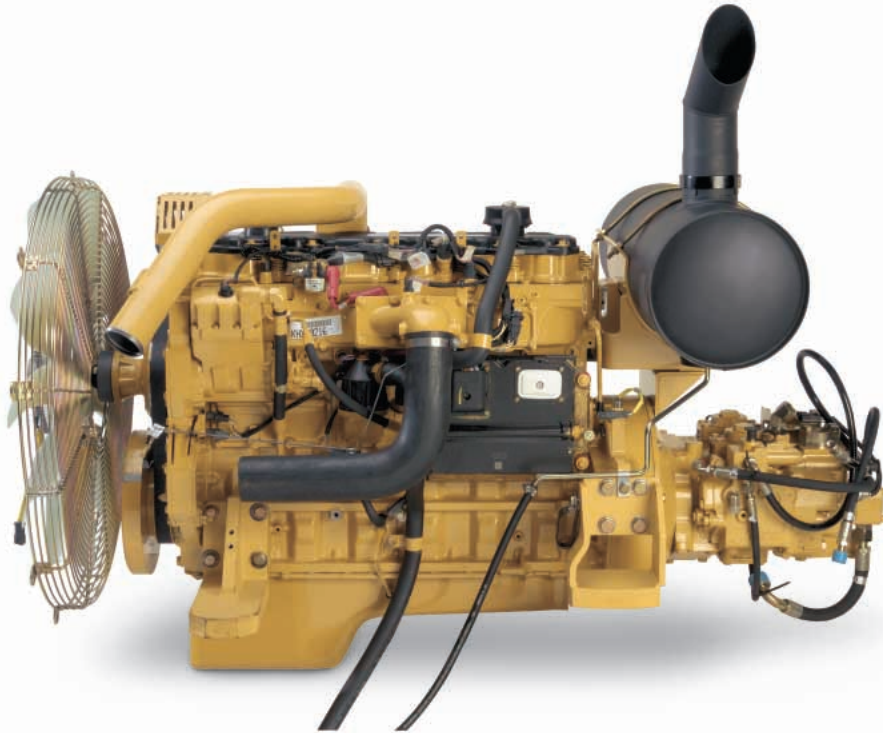

Cat C7. The Cat C7 with ACERT™ Technology introduces a series of evolutionary, incremental improvements that provide breakthrough engine technology. The building blocks of ACERT Technology are fuel delivery, air management and electronic control. ACERT Technology optimizes engine performance while meeting U.S. EPA Tier 3 emission regulations.

Performance. The 324D L, equipped with the C7 engine with ACERT™ Technology, provides 12% more horsepower as compared to the 3126B ATAAC HEUI in the 325C L.

Automatic Engine Speed Control.

The two-stage, one-touch control maximizes fuel efficiency and reduces sound levels.

ADEM™ A4 Engine Controller.

The ADEM A4 electronic control module manages fuel delivery to get the best performance per liter of fuel used. The engine management system provides flexible fuel mapping, allowing the engine to respond quickly to varying application needs. It tracks engine and machine conditions while keeping the engine operating at peak efficiency.

Electronic Control Module.

The Electronic Control Module (ECM) works as the “brain” of the engine’s control system, responding quickly to operating variables to maximize engine efficiency. Fully integrated with sensors in the engine’s fuel, air, coolant, and exhaust systems, the ECM stores and relays information on conditions such as rpm, fuel consumption, and diagnostic information.

Fuel Delivery. The Cat C7 features electronic controls that govern the fuel injection system. Multiple injection fuel delivery involves a high degree of precision. Precisely shaping the combustion cycle lowers combustion chamber temperatures, generating fewer emissions and optimizing fuel combustion. This translates into more work output for your fuel cost.

Cooling System. The cooling fan is directly driven from the engine. An electrically controlled viscous clutch fan is available as an attachment to reduce fan noise. The optimum fan speed is calculated based on the target engine speed, coolant temperature, hydraulic oil temperature and actual fan speed. The Cat C7 delivered a completely new layout that separates the cooling system from the engine compartment.

Air Cleaner. The radial seal air filter features a double-layered filter core for more efficient filtration and is located in a compartment behind the cab. A warning is displayed on the monitor when dust accumulates above a preset level.

Noise Reduction Technologies.

The engine mounts are rubber-isolating mounts matched with the engine package. Further noise reduction has been achieved through design changes to the isolated top cover, oil pan, multiple injection strategy, insulated timing cover, sculpted crankcase and gear train refinements.

Hydraulics

Cat® hydraulics deliver power and precise control to keep material moving.

Component Layout. The 324D hydraulic system and component locations have been designed to provide a high level of system efficiency. The main pumps, control valves and hydraulic tank are located close together to allow for shorter tubes and lines between components that reduce friction loss and pressure drops in the lines. The layout further provides greater operator comfort by placing the radiator on the cab side of the upper structure. This allows incoming air to enter the engine compartment from the operator side and hot air and corresponding engine sound to exit on the opposite side away from the operator. This reduces engine compartment heat and sound being transmitted to the operator.

Pilot System. The pilot pump is independent from the main pumps and controls the front linkage, swing and travel operations.

Hydraulic Cross Sensing System. The hydraulic cross sensing system utilizes each of two hydraulic pumps to 100 percent of engine power, under all operating conditions. This improves productivity with faster implement speeds and quicker, stronger pivot turns.

Boom and Stick Regeneration Circuit. Boom and stick regeneration circuit saves energy during boom-down and stick-in operation which increases efficiency, reduces cycle times and pressure loss for higher productivity, lower operating costs and increased fuel efficiency.



Auxiliary Hydraulic Valve. The auxiliary valve is standard on the 324D. Control Circuits are available as attachments, allowing for operation of high and medium pressure tools such as shears, grapples, hammers, pulverizers, multi-processors and vibratory plate compactors.

Hydraulic Cylinder Snubbers. Snubbers are located at the rod-end of the boom cylinders and both ends of the stick cylinders to cushion shocks while reducing sound levels and extending component life.

Operator Comfort

Designed for comfort, simple and easy operation, the 324D allows the operator to focus on production.



Operator Station. The workstation is spacious, quiet and comfortable, assuring high productivity during a long work day. The air conditioner and attachment switches are conveniently located on the right-hand wall, and the key switch and throttle dial are on the right-hand console.



Monitor. The monitor is a full color 400x234 pixels Liquid Crystal Display (LCD) graphic display. The monitor angle can be adjusted to minimize sun glare and has the capability of displaying information in twenty-seven different languages.

Pre-Start Check. Prior to starting the machine, the system will check for low fluid levels for the engine oil, hydraulic oil and engine coolant and warn the operator through the monitor in the event display area.

Gauge Display. Three analog gauges, fuel level, hydraulic oil temperature and coolant temperature, are displayed in this area.

Event Display. Machine information is displayed in this area with the icon and language.

Multi-information Display. This area is reserved for displaying various information which is convenient for the operator. The “CAT” logo is displayed when no information is available to be displayed.

Standard Cab Equipment. To enhance operator comfort and productivity, the cab includes a lighter, drink holder, coat hook, service meter, literature holder, magazine rack and storage compartment.

Seat. A new optional air suspension seat is available in the 324D. The standard and optional seats provide a variety of adjustments to suit the operator’s size and weight including fore/aft, height and weight. Wide adjustable armrests and a retractable seat belt are also included.

Joystick Control. Joystick controls have low lever effort and are designed to match the operator’s natural wrist and arm position. The operator can operate joystick controls with an arm on the armrest and the horizontal and vertical strokes have been designed to reduce operator fatigue.

Hydraulic Activation Control Lever. For added safety, this lever must be in the operate position to activate the machine control functions.

Automatic Climate Control. Fully automatic climate control adjusts temperature and flow, and determines which air outlet is best in each situation with a touch of a button.



Console. Redesigned consoles feature a simple, functional design to reduce operator fatigue, ease of switch operation and excellent visibility. Both consoles have attached armrests with height adjustments.

Cab Exterior. The exterior design uses thick steel tubing along the bottom perimeter of the cab, improving the resistance of fatigue and vibration. This design allows the FOGS to be bolted directly to the cab, at the factory or as an attachment later, enabling the machine to meet specifications and job site requirements.

Cab Mounts. The cab shell is attached to the frame with viscous rubber cab mounts, which dampen vibrations and sound levels while enhancing operator comfort.

Windows. All glass is affixed directly to the cab for excellent visibility eliminating window frames. The upper front windshield opens, closes and stores on the roof above the operator with a one-touch action release system.

Wipers. Pillar-mounted wipers increase the operator’s viewing area and offer continuous and intermittent modes.

Skylight. An enlarged skylight with sunshade provides excellent visibility and ventilation.

Structures

324D structural components and undercarriage are the backbone of the machine's durability.

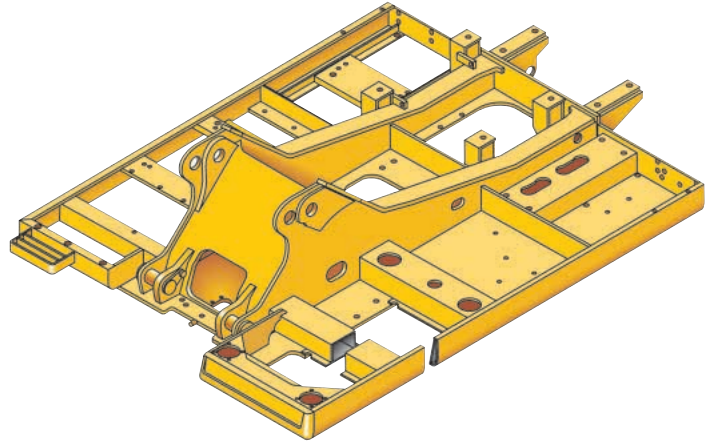
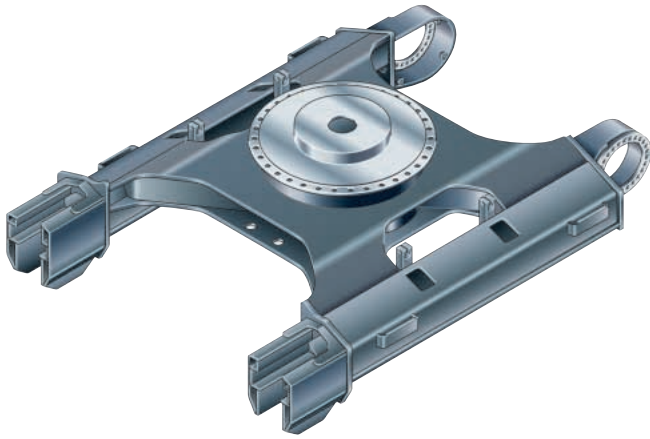

Robotic Welding. Up to 95% of the structural welds on a Caterpillar® Excavator are completed by robots. Robotic welds achieve over three times the penetration of manual welds.

Carbody Design and Track Roller Frames. X-shaped, box-section carbody provides excellent resistance to torsion bending. Robot-welded track roller frames are press-formed, pentagonal units to deliver exceptional strength and service life.

Main Frame. Rugged main frame is designed for maximum durability and efficient use of materials.

Undercarriage. Durable Cat® undercarriage absorbs stresses and provides excellent stability.

Swing Bearing. The swing bearing utilizes cross roller bearings versus the traditional ball bearing design. The cross roller bearing design allows for more surface contact to absorb the stresses that are a result of the high swing torque that Cat offers. It provides exceptional machine stability and reduces machine pitching during boom down operation.

Rollers and Idlers. Sealed and lubricated track rollers, carrier rollers, and idlers provide excellent service life, to keep the machine in the field longer.

Long Undercarriage. The long (L) undercarriage maximizes stability and lift capacity. This long, wide, and sturdy undercarriage offers a very stable work platform.

Booms, Sticks and Bucket Linkages

Built for performance and long service life, Caterpillar® booms and sticks are large, welded, box-section structures with thick, multi-plate fabrications in high stress areas.

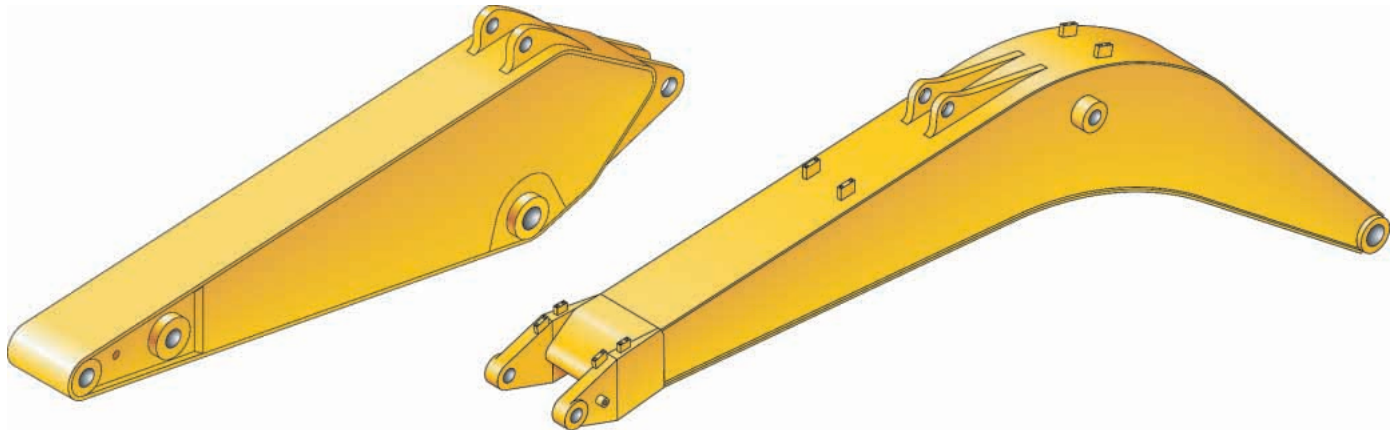

Reach Boom. The reach boom features an optimum design that maximizes digging envelopes with three stick choices:

R3.6B and R2.95CB Sticks. These sticks have enough capacity for excellent reach and depth in trenching and general construction applications.

R2.5CB Stick. This stick has been designed with enough reach and depth to match a large-capacity bucket and higher stick digging forces than the longer reach sticks.

Mass Excavation Boom. The mass excavation boom maximizes productivity. The mass version offers significantly higher digging forces and allows use of larger buckets.

M2.5DB. The DB Stick uses a D-family bucket and was designed for high volume earth moving, powerful digging force and a large capacity bucket. Combined with a Mass boom, this stick delivers outstanding productivity.

Super Long Reach. This configuration offers reaches to over 8.3 m (60 feet). It is well suited for ditch cleaning applications.

Linkage Pins. The bucket linkage pins have been enlarged to improve reliability and durability. All the pins in the front linkages have thick chrome plating, giving them high wear and corrosion resistance.

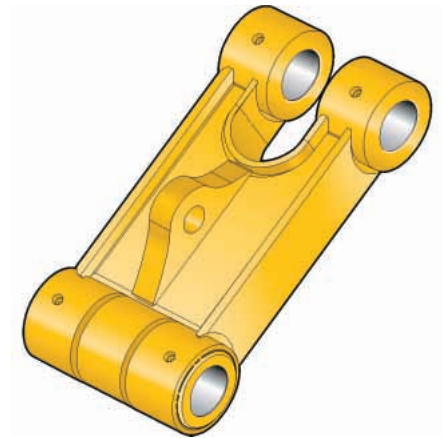

Bucket Linkage. The power link improves durability, increases machine-lifting capability in key lifting positions and with the integrated lift-eye it is easier to use than compared to the previous power link.

Work Tools – Attachments

The 324D has an extensive selection of work tools to optimize machine performance.



Heavy Duty Buckets. Heavy-duty (HD) buckets are used for a wide range of moderately abrasive applications such as mixed dirt, clay and rock. HD buckets have best loading and dumping characteristics and will empty easier in cohesive material. More robust construction than the GP buckets.

General Purpose Capacity (GP-C) Buckets. General Purpose Capacity Buckets are best for digging in soft to hard ground with low to moderately abrasive materials.

Heavy-Duty Power (HDP) Buckets. For use in moderately abrasive applications where breakout force and cycle times are critical. Maximizes tip force and improves cycle times in most materials.

Heavy Duty Rock Buckets. Heavy duty rock for aggressive bucket loading in highly abrasive application such as shot rock and granite. Features include:

- Thickest wear plates to extend the life of bucket in severe applications
- Side wear plated extend further up the side of the bucket for maximum protection in rocky soils
- Buckets accept sidebar protectors for best sidebar protection, or sidecutters for best fill characteristics and bucket wear protection

Ditch Cleaning (DC) Buckets.

These wide shallow buckets are best for bank forming, ditch cleaning, and finishing.

Caterpillar Ground Engaging Tools (GET).

All bucket in the CB/DB Family utilize the Caterpillar K Series® GET. This GET system uses a vertical retainer that is easier to remove and install than the Cat J Series pin. The tip shapes are more aggressive and offer better penetration than the previous generation of tips. There are also a variety of side cutters and sidebar protectors to match operating conditions.



Hammer

Cat Hydraulic Hammers are precisely matched to Cat machines for optimum performance in a wide variety of demolition and construction applications.



Thumb

Cat thumbs multiply the capabilities of your excavator. This Highly versatile tool works in conjunction with the bucket to transform an excavator into a versatile material-handling machine.



Multi-processor

Multi-processors do the work of many types of demolition tools by use of interchangeable jaw sets. Changing jaws allows a single unit to crush, pulverize and perform a variety of specialized cutting tasks, such as cutting steel rebar and tanks.

Versatility

A wide variety of optional factory-installed attachments are available to enhance performance and improve job site management.



Tool Control System. This system offers the most flexibility and versatility of the auxiliary options offered. This system is available in two configurations, as a stand-alone system or with a medium pressure circuit and third pump. This system is capable of running either one-way or two-way tools and one one-pump or two pump tools. The additional of the medium pressure circuit allows use of tools that rotate such as grapples, shears or multi-processors. Up to 10 different tool settings can be pre-programmed and selected through the monitor.

Auxiliary Hydraulics Options. There are four different options that can be factory installed to meet the various demands for hydra-mechanical tools. Single-Function, Double-Function, Tool Control System without Medium Pressure and Tool Control System with Medium Pressure are available as a factory installed option.

Single-Function Auxiliary Hydraulics.

This circuit utilizes one-way flow action with two pumps and can run tools such as hammers and vibratory plate compactors.

Double-Function Auxiliary Hydraulics.

This circuit utilizes two-way flow and one pump and is capable of running tools such as a thumb, tilt-bucket or non-rotating grapples or shears.



Machine Security. An optional Machine Security System is available from the factory on the 324D L. This system controls when the machine can be operated and utilizes specific keys to prevent unauthorized machine use, a significant theft deterrent.

Product Link. The machine is pre-wired to accept Product Link systems to be installed in the field. Product Link is also available as a factory installed attachment. Product Link can assist with Fleet Management that will keep track of hours, location, security and product health.



Pin Grabber Plus Hydraulic Pin Grabber

Increases versatility of the excavator by allowing the machine to pick up a wide variety of work tools without leaving the cab.



360 Scrap Shear

Caterpillar Scrap Shears feature 360° rotation and a high force-to-weight ratio. Used for demolishing steel structures, and preparing bulk scrap (such as cars, farm machinery and railroad cars) for further processing.

Service and Maintenance

Simplified service and maintenance features save you time and money.

Ground Level Service. The design and layout of the 324D was made with the service technician in mind. Many service locations are easily accessible at ground level allowing critical maintenance to get done quickly and efficiently.



Air Filter Compartment. The air filter features a double-element construction for superior cleaning efficiency. When the air cleaner plugs, a warning is displayed on the monitor screen inside the cab.

Pump Compartment. A service door on the right side of the upper structure allows ground-level access to the pump and pilot filter.



Radiator Compartment. The left rear service door allows easy access to the engine radiator, oil cooler and air-to-air-after-cooler. A reserve tank and drain cock are attached to the radiator for simplified maintenance.



Greasing Points. A concentrated remote greasing block on the boom delivers grease to hard-to-reach locations on the front.

Capsule Filter. The hydraulic return filter, a capsule filter, is situated outside the hydraulic tank. This filter prevents contaminants from entering the system when hydraulic oil is changed and keeps the operation clean.

Fan Guard. Engine radiator fan is completely enclosed by fine wire mesh, reducing the risk of an accident.

Anti-Skid Plate. Anti-skid plate covers top of storage box and upper structure to prevent slipping during maintenance.



Diagnostics and Monitoring. The 324D is equipped with S•O•SSM sampling ports and hydraulic test ports for the hydraulic system, engine oil, and for coolant. A test connection for the Cat Electronic Technician (Cat ET) service tool is located in the cab.

Extended Service Interval. 324D service and maintenance intervals have been extended to reduce machine service time and increase machine availability.

Complete Customer Support

Cat® dealer services help you operate longer with lower costs.



Product Support. You will find nearly all parts at our dealer parts counter. Cat dealers utilize a worldwide computer network to find in-stock parts to minimize machine down time. Save money with remanufactured components.

Machine Selection. Make detailed comparisons of the machines you are considering before you buy. What are the job requirements, machine attachments and operating hours? What production is needed? Your Cat dealer can provide recommendations.

Customer Support Agreements.

Cat dealers offer a variety of product support agreements, and work with customers to develop a plan the best meets specific needs. These plans can cover the entire machine, including attachments, to help protect the customer's investment.

Operation. Improving operating techniques can boost your profits. Your Cat dealer has videotapes, literature and other ideas to help you increase productivity, and Caterpillar offers certified operator training classes to help maximize the return on your investment.

Maintenance Services. Repair option programs guarantee the cost of repairs up front. Diagnostic programs such as Scheduled Oil Sampling, Coolant Sampling and Technical Analysis help you avoid unscheduled repairs.

Replacement. Repair, rebuild, or replace? Your Cat dealer can help you evaluate the cost involved so you can make the right choice.

SAFETY.CAT.COM™.

Engine

Engine Model	Cat® C7 with ACERT™ Technology	
Net Flywheel Power	140 kW	188 hp
Net Power – ISO 9249	140 kW	188 hp
Net Power – SAE J1349	139 kW	186 hp
Net Power – EEC 80/1269	140 kW	188 hp
Bore	110 mm	4.33 in
Stroke	127 mm	5 in
Displacement	7.2 L	439.4 in ³

- The 324D L meets U.S. EPA Tier III and EU Stage III engine emissions requirements.
- Net flywheel power advertised is the power available at the flywheel when the engine is equipped with fan, air cleaner, muffler and alternator.
- No engine derating needed up to 2300 m (7,500 ft).

Weights

Operating Weight	24 790 kg	54,660 lb
------------------	-----------	-----------

- Base Machine, Reach Boom, R2.95CB1 (9 ft 8 in) Stick, 1.1 m³ (1.44 yd³) Bucket, 800 mm (32 in) Shoes.

NOTE – The above configuration does not include any optional attachments.

Track

Standard w/Long Undercarriage	800 mm	32 in
Optional	700 mm	28 in
Optional – Double Grouser	600 mm	23.62 in
Number of Shoes Each Side – Long Undercarriage	51	
Number of Track Rollers Each Side – Long Undercarriage	8	
Number of Carrier Rollers Each Side – Long Undercarriage	2	

Swing Mechanism

Swing Speed	9.6 rpm	
Swing Torque	73.4 kN·m	54,137 lb ft

Service Refill Capacities

Fuel Tank Capacity	520 L	137 gal
Cooling System	31 L	8.2 gal
Engine Oil	30 L	8 gal
Swing Drive	10 L	2.6 gal
Final Drive (each)	6 L	1.6 gal
Hydraulic System (including tank)	300 L	79 gal
Hydraulic Tank	145 L	38 gal

Drive

Maximum Drawbar Pull	227 kN	51,032 lb
Maximum Travel Speed	5.4 km/h	3.4 mph

Hydraulic System

Main Implement System – Maximum Flow (2x)	220 L/min	58 gal/min
Max. pressure – Equipment	35 000 kPa	5,076 psi
Max. pressure – Equipment – Heavy	36 000 kPa	5,221 psi
Max. pressure – Travel	35 000 kPa	5,076 psi
Max. pressure – Swing	24 500 kPa	3,553 psi
Pilot System – Maximum flow	32.4 L/min	9 gal/min
Pilot System – Maximum pressure	3900 kPa	566 psi
Boom Cylinder – Bore	135 mm	5.3 in
Boom Cylinder – Stroke	1305 mm	51.4 in
Stick Cylinder – Bore	140 mm	5.5 in
Stick Cylinder – Stroke	1660 mm	65.4 in
B1 Family Bucket Cylinder – Bore	120 mm	4.7 in
B1 Family Bucket Cylinder – Stroke	1104 mm	43.5 in
CB1 Family Bucket Cylinder – Bore	130 mm	5.1 in
CB1 Family Bucket Cylinder – Stroke	1156 mm	45.5 in
DB Family Bucket Cylinder – Bore	150 mm	5.9 in
DB Family Bucket Cylinder – Stroke	1151 mm	45.3 in

Sound Performance

Performance	ANSI/SAE J1166 APR 90
-------------	-----------------------

- When properly installed and maintained, the cab offered by Caterpillar, when tested with doors and windows closed according to ANSI/SAE J1166 OCT 98, meets OSHA and MSHA requirements for operator sound exposure limits in effect at time of manufacture.
- Hearing protection may be needed when operating with an open operator station and cab (when not properly maintained or doors/windows open) for extended periods or in noisy environment.

Standards

Brakes	SAE J1026 APR90
Cab/FOGS	SAE J1356 FEB88

Dimensions

All dimensions are approximate.

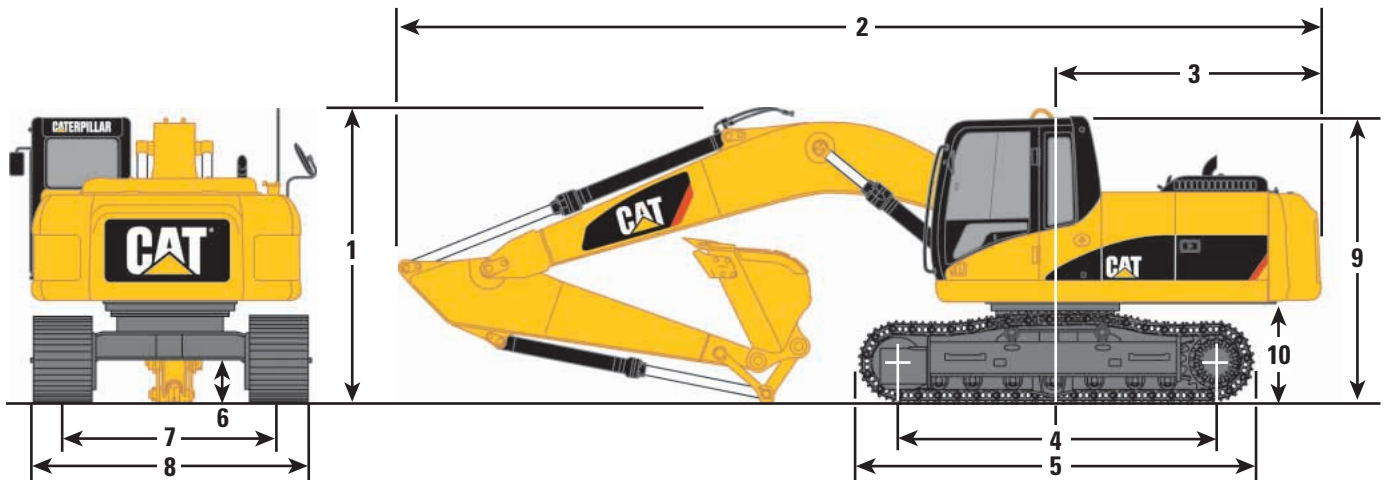

Boom Options	Reach Boom 5.9 m (19'4")			Mass Boom 5.3 m (17'5")
Stick Options	R3.6B1 (11'10")	R2.95CB1 (9'8")	R2.5CB1 (8'2")	M2.5DB (8'2")
1 Shipping height	3430 mm (11'3")	3170 mm (10'5")	3300 mm (10'10")	3450 mm (11'4")
2 Shipping length	10 050 mm (33'0")	10 060 mm (33'0")	10 100 mm (33'2")	9480 mm (31'1")
3 Tail swing radius	3000 mm (9'10")	3000 mm (9'10")	3000 mm (9'10")	3000 mm (9'10")
Undercarriage				
4 Length to center of rollers	3830 mm (12'7")	3830 mm (12'7")	3830 mm (12'7")	3830 mm (12'7")
5 Track length	4630 mm (15'2")	4630 mm (15'2")	4630 mm (15'2")	4630 mm (15'2")
6 Ground clearance	440 mm (1'5")	440 mm (1'5")	440 mm (1'5")	440 mm (1'5")
7 Track gauge	2590 mm (8'6")	2590 mm (8'6")	2590 mm (8'6")	2590 mm (8'6")
8 Transport width				
800 mm (32") shoes (standard)	3390 mm (11'1")	3390 mm (11'1")	3390 mm (11'1")	3390 mm (11'1")
700 mm (28") shoes (optional)	3290 mm (10'10")	3290 mm (10'10")	3290 mm (10'10")	3290 mm (10'10")
600 mm (24") shoes (optional)	3190 mm (10'6")	3190 mm (10'6")	3190 mm (10'6")	3190 mm (10'6")
9 Cab height	2980 mm (9'9")	2980 mm (9'9")	2980 mm (9'9")	2980 mm (9'9")
10 Counterweight clearance	1060 mm (3'6")	1060 mm (3'6")	1060 mm (3'6")	1060 mm (3'6")

Reach Excavator Working Ranges

Reach (R) boom configuration

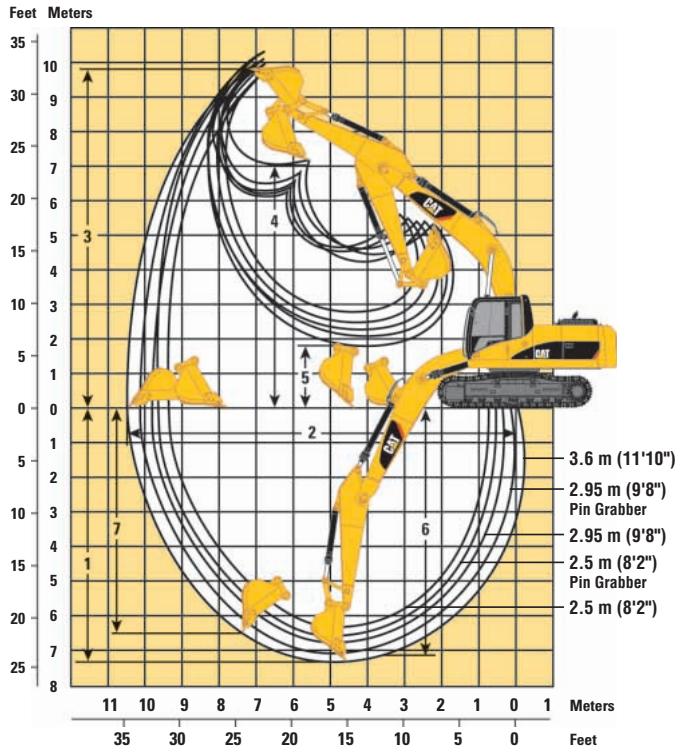

Mass Excavator Working Ranges

Mass (M) boom configuration

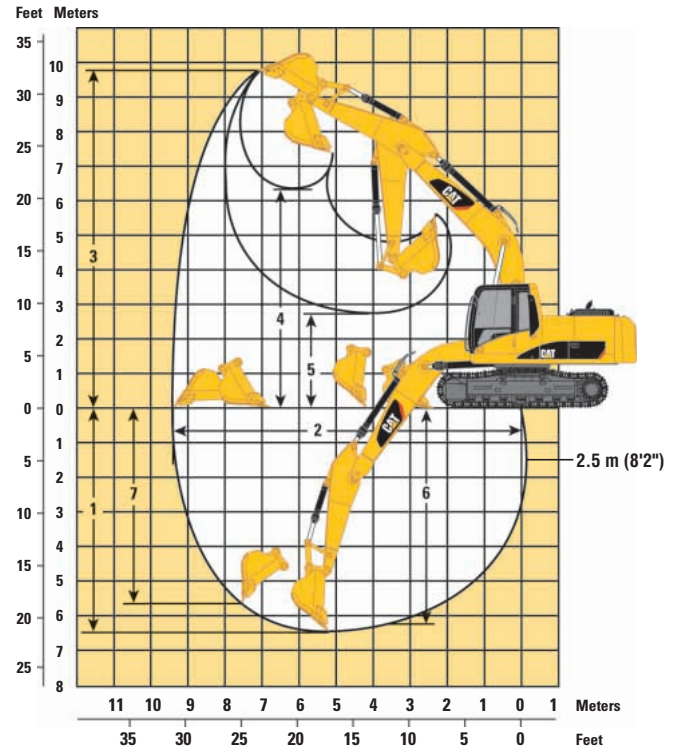

Boom Options

Reach Boom 5.9 m (19'4")

Mass Boom 5.3 m (17'5")

Stick Options

R3.6B1
(11'10")

R2.95CB1
(9'8")

R2.5CB1
(8'2")

R2.95CB1
(9'8")

R2.5CB1
(8'2")

M2.5DB
(8'2")

Bucket Options

GP-C 1.17 m³
(1.53 yd³)

HD 1.35 m³
(1.77 yd³)

HD 1.35 m³
(1.77 yd³)

HD 1.35 m³
(1.77 yd³)
with Pin Grabber Coupler

HD 1.35 m³
(1.77 yd³)
with Pin Grabber Coupler

HD 1.87 m³
(2.45 yd³)

	R3.6B1 (11'10")	R2.95CB1 (9'8")	R2.5CB1 (8'2")	R2.95CB1 (9'8")	R2.5CB1 (8'2")	M2.5DB (8'2")
1 Maximum digging depth	7328 mm (24'1")	6846 mm (22'6")	6396 mm (21'0")	7134 mm (23'5")	6684 mm (21'11")	6488 mm (21'3")
2 Maximum reach at ground level	10 549 mm (34'7")	9829 mm (32'3")	9395 mm (30'10")	10 094 mm (33'1")	9700 mm (31'10")	9446 mm (31'0")
3 Maximum cutting height	9887 mm (32'5")	9946 mm (32'8")	9750 mm (32'0")	10 249 mm (33'8")	10 054 mm (33'0")	9849 mm (32'4")
4 Maximum loading height	7043 mm (23'1")	6590 mm (21'7")	6394 mm (21'0")	6302 mm (20'8")	6106 mm (20'0")	6302 mm (20'8")
5 Minimum loading height	1884 mm (6'2")	2365 mm (7'9")	2823 mm (9'3")	2077 mm (6'10")	2535 mm (8'4")	2731 mm (9'0")
6 Maximum depth cut for 2440 mm (8') level bottom	7174 mm (23'6")	6672 mm (21'11")	6199 mm (20'4")	6974 mm (22'11")	6505 mm (21'4")	6298 mm (20'8")
7 Maximum vertical wall digging depth	6575 mm (21'7")	6075 mm (19'11")	5633 mm (18'6")	3877 mm (12'9")	3490 mm (11'5")	5694 mm (18'8")

Dimensions

All dimensions are approximate.

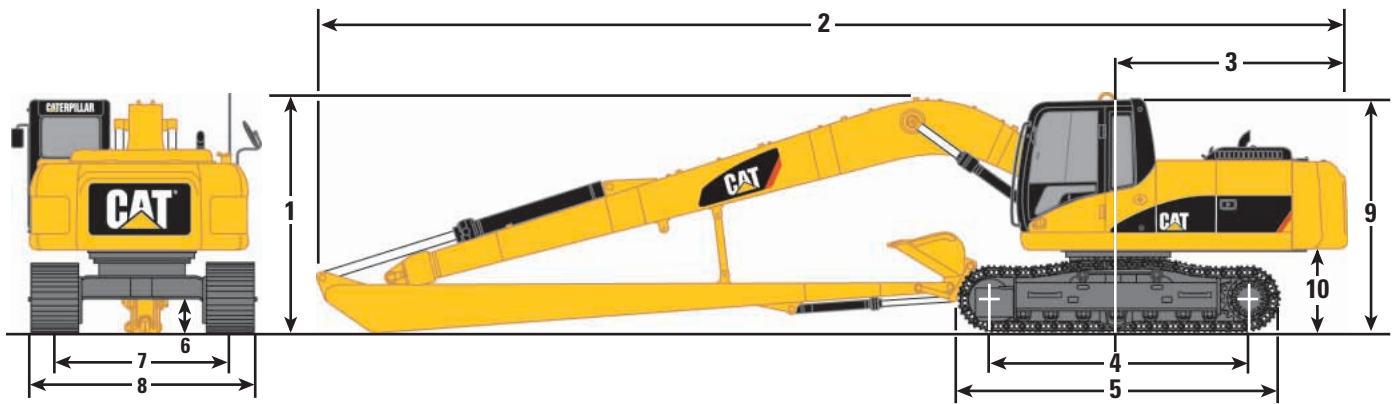

Boom Options

Super Long Reach Boom

10.2 m (33'6")

Stick Options

7.85 m (25'9")

1 Shipping height	3150 mm (10'4")
2 Shipping length	14 340 mm (47'1")
3 Tail swing radius	3000 mm (9'10")
4 Length to center of rollers	3830 mm (12'7")
5 Track length	4630 mm (15'2")
6 Ground clearance	440 mm (1'5")
7 Track gauge	2590 mm (8'6")
8 Transport width	
800 mm (32") shoes (standard)	3390 mm (11'1")
700 mm (28") shoes (optional)	3290 mm (10'10")
600 mm (24") shoes (optional)	3190 mm (10'6")
9 Cab height	2980 mm (9'9")
10 Counterweight clearance	1060 mm (3'6")

Reach Excavator Working Ranges

Reach (R) boom configuration

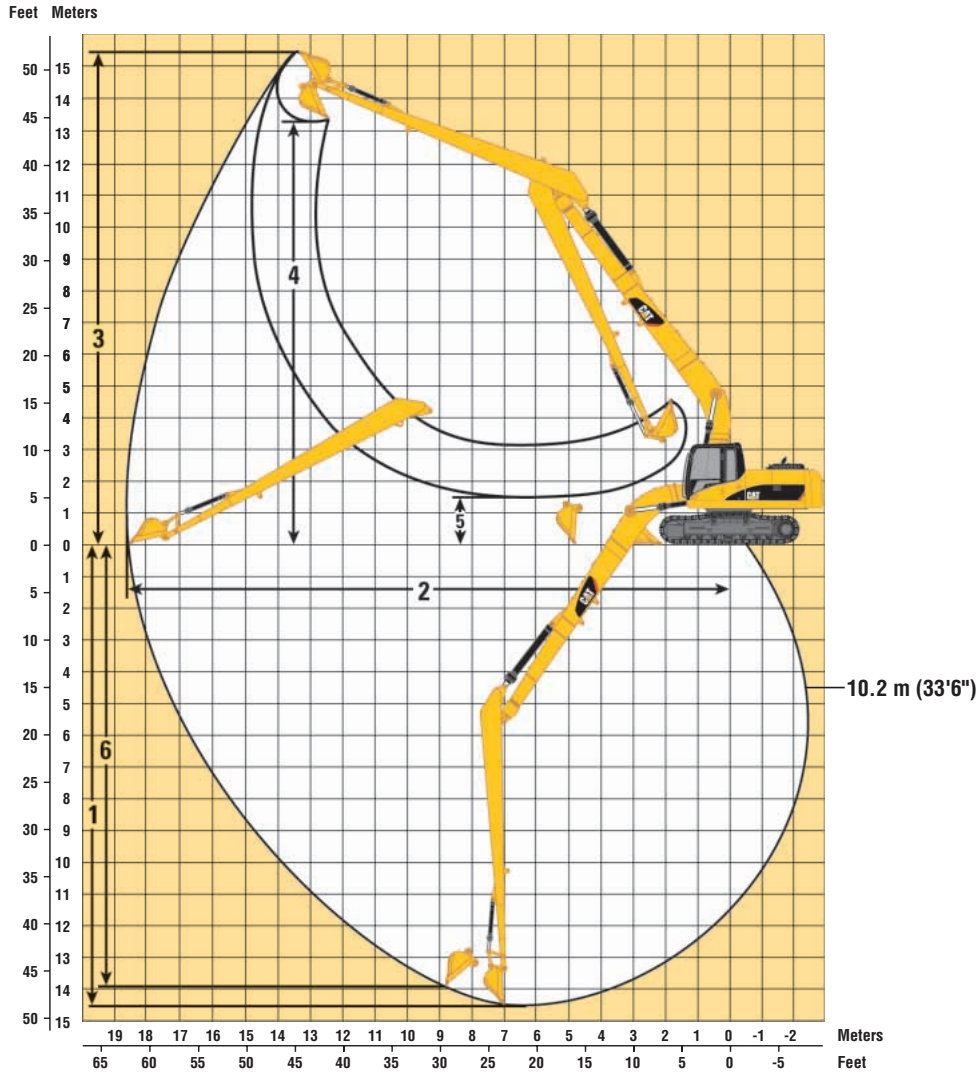

Boom Options

Super Long Reach Boom

Stick Options

10.2 m (33'6")

Bucket Options

7.85 m (25'9")

1	Maximum digging depth	14 594 mm (47'11")
2	Maximum reach at ground level	18 603 mm (61'0")
3	Maximum cutting height	15 411 mm (50'7")
4	Maximum loading height	13 285 mm (43'7")
5	Minimum loading height	1483 mm (4'10")
6	Maximum vertical wall digging depth	13 922 mm (45'7")

Bucket and Stick Forces

Stick Options	R3.6B1		R2.95CB1		R2.95CB1 with Pin Grabber Coupler		R2.5CB1		R2.5CB1 with Pin Grabber Coupler		M2.5DB	
	kN	lb	kN	lb	kN	lb	kN	lb	kN	lb	kN	lb
Power Buckets												
Bucket Digging Force (ISO)	172	38,667	186	41,814	150	33,721	186	41,814	150	33,721	239	53,729
Stick Digging Force (ISO)	113	25,471	127	28,551	119	26,752	148	33,272	137	30,799	147	33,047
Bucket Digging Force (SAE)	152	34,171	163	36,644	145	32,597	163	36,644	146	32,822	210	47,210
Stick Digging Force (SAE)	111	24,954	123	27,651	118	26,527	143	32,148	136	30,574	142	31,923
HD and HDR Buckets												
Bucket Digging Force (ISO)	147	33,047	166	37,318	143	32,148	167	37,543	144	32,372	215	48,334
Stick Digging Force (ISO)	111	24,954	124	27,876	117	26,303	144	32,372	135	30,349	143	32,148
Bucket Digging Force (SAE)	132	29,675	147	33,047	131	29,450	147	33,047	132	29,675	190	42,714
Stick Digging Force (SAE)	108	24,279	120	26,977	114	25,628	139	31,248	131	29,450	138	31,024

Major Component Weights

	kg	lb
Base machine with counterweight (without front linkage)		
With 800 mm (32") shoes	20 740	45,724
Two boom cylinders (each)	227	500
Counterweight		
Standard counterweight	4520	9,965
Super long reach counterweight	6760	14,903
Boom (includes lines, pins and stick cylinder)		
Reach boom 5.9 m (19'5")	2033	4,482
Mass boom 5.3 m (17'5")	2138	4,713
Super long reach boom 10.2 m (33'5")	3580	7,893
Stick (includes lines, pins, bucket cylinder and linkage)		
R3.6B1 (11'10")	1199	2,643
R2.95CB1 (9'8")	1208	2,663
R2.5CB1 (8'2")	1149	2,533
M2.5DB (8'2")	1470	3,241
Super long reach stick 7.85 m (25'9")	1610	3,549

Bucket Specifications and Compatibility

Bucket Type	Adaptor	Capacity*		Width		Tip Radius		Teeth Qty	Total Weight		Reach Boom Stick		
		m ³	yd ³	mm	in	mm	in		kg	lb	R3.6B1	R2.95CB1	R2.5CB1
CB1 Family Buckets													
General Purpose – Capacity	K90	0.63	0.82	610	24	1656.3	65.2	3	729	1,606	—	●	●
	K90	0.86	1.12	762	30	1656.3	65.2	4	847	1,868	—	●	●
	K90	1.09	1.43	914	36	1656.3	65.2	5	951	2,097	—	●	●
	K90	1.34	1.75	1067	42	1656.3	65.2	5	1024	2,258	—	●	●
	K90	1.58	2.07	1219	48	1656.3	65.2	6	1121	2,471	—	◐	●
	K90	1.83	2.39	1372	54	1656.3	65.2	7	1218	2,684	—	○	◐
Heavy Duty	K100	0.53	0.69	610	24	1686.3	66.4	3	780	1,720	—	●	●
	K100	0.73	0.95	762	30	1686.3	66.4	3	858	1,891	—	●	●
	K100	0.93	1.22	914	36	1686.3	66.4	4	982	2,165	—	●	●
	K100	1.14	1.49	1067	42	1686.3	66.4	5	1073	2,365	—	●	●
	K100	1.35	1.77	1219	48	1686.3	66.4	5	1143	2,519	—	●	●
	K100	1.57	2.05	1372	54	1686.3	66.4	6	1238	2,730	—	◐	◐
	K100	1.78	2.33	1524	60	1686.3	66.4	7	1334	2,941	—	○	○
	K100	1.99	2.60	1676	66	1686.3	66.4	7	1406	3,101	—	∴	○
Heavy Duty Rock	K100	0.73	0.95	762	30	1686.3	66.4	3	965	2,127	—	●	●
	K100	0.93	1.22	914	36	1686.3	66.4	4	1073	2,365	—	●	●
	K100	1.14	1.49	1067	42	1686.3	66.4	5	1174	2,588	—	●	●
	K100	1.35	1.77	1219	48	1686.3	66.4	5	1259	2,775	—	●	●
Heavy Duty Power	K100	1.12	1.46	1067	42	1592.1	62.7	5	1060	2,337	—	●	●
	K100	1.33	1.74	1219	48	1592.1	62.7	5	1137	2,507	—	●	●
	K100	1.53	2.00	1372	54	1592.1	62.7	6	1237	2,727	—	◐	●
Ditch Cleaning	N/A	1.25	1.63	1534	60	1262.0	49.7	—	739	1,629	—	●	●
	N/A	1.53	2.00	1830	72	1262.0	49.7	—	837	1,845	—	●	●

Assumptions for maximum material density rating:

1. Front linkage fully extended at ground line
2. Bucket curled
3. 100% bucket fill factor

* Based on SAE J296, some calculations of capacity specs fall on borderlines. Rounding may allow two buckets to have the same English rating, but different metric ratings.

- 2100 kg/m³ (3,500 lb/yd³) max material density
- ◐ 1800 kg/m³ (3,000 lb/yd³) max material density
- 1500 kg/m³ (2,500 lb/yd³) max material density
- ∴ 1200 kg/m³ (2,000 lb/yd³) max material density
- Not Available

Bucket Specifications and Compatibility

Bucket Type	Adaptor	Capacity*		Width		Tip Radius		Teeth Qty	Total Weight		Reach Boom Stick R3.6B1
		m ³	yd ³	mm	in	mm	in		kg	lb	
B Family Buckets											
General Purpose – Capacity	K80	0.57	0.74	610	24	1524.0	60.0	3	646	1,425	●
	K80	0.77	1.01	762	30	1524.0	60.0	4	704	1,551	●
	K80	0.95	1.24	914	36	1524.0	60.0	5	798	1,760	●
	K80	1.17	1.53	1067	42	1524.0	60.0	5	857	1,889	●
	K80	1.39	1.82	1219	48	1524.0	60.0	6	1002	2,208	◐
	K80	1.57	2.05	1372	54	1524.0	60.0	6	1011	2,228	◐
Heavy Duty	K90	0.54	0.70	610	24	1578.0	62.1	3	680	1,500	●
	K90	0.77	1.00	762	30	1578.0	62.1	4	772	1,702	●
	K90	0.84	1.10	914	36	1578.0	62.1	5	852	1,878	●
	K90	1.07	1.40	1067	42	1578.0	62.1	5	913	2,013	●
	K90	1.22	1.60	1219	48	1578.0	62.1	6	1007	2,220	●
	K90	1.38	1.80	1372	54	1578.0	62.1	6	1084	2,389	◐
Heavy Duty Rock	K90	0.54	0.70	610	24	1578.0	62.1	3	731	1,612	●
	K90	0.77	1.00	762	30	1578.0	62.1	4	828	1,826	●
	K90	0.84	1.10	914	36	1578.0	62.1	5	922	2,033	●
	K90	1.07	1.40	1067	42	1578.0	62.1	5	992	2,187	●
Heavy Duty Power	K90	0.84	1.10	914	36	1404.0	55.3	5	843	1,858	●
	K90	0.99	1.30	1067	42	1404.0	55.3	5	902	1,989	●
	K90	1.15	1.50	1219	48	1404.0	55.3	6	1003	2,211	●
Ditch Cleaning	N/A	0.99	1.30	1524	60	1143.0	45.0	—	736	1,623	●
	N/A	1.24	1.62	1830	72	1143.0	45.0	—	844	1,861	●

Assumptions for maximum material density rating:

1. Front linkage fully extended at ground line
2. Bucket curled
3. 100% bucket fill factor

* Based on SAE J296, some calculations of capacity specs fall on borderlines. Rounding may allow two buckets to have the same English rating, but different metric ratings.

- 2100 kg/m³ (3,500 lb/yd³) max material density
- ◐ 1800 kg/m³ (3,000 lb/yd³) max material density

Bucket Specifications and Compatibility

Bucket Type	Adaptor	Capacity*		Width		Tip Radius		Teeth Qty	Total Weight		Mass Boom Stick M2.5DB
		m ³	yd ³	mm	in	mm	in		kg	lb	
DB Family Buckets											
General Purpose	K100	0.94	1.23	762	30	1753.4	69.0	3	993	2,189	●
	K100	1.19	1.56	914	36	1753.4	69.0	4	1088	2,398	●
	K100	1.46	1.91	1067	42	1753.4	69.0	5	1200	2,646	●
	K100	1.73	2.26	1219	48	1753.4	69.0	5	1288	2,839	◐
	K100	2.00	2.62	1372	54	1753.4	69.0	6	1401	3,089	○
	K100	2.27	2.97	1524	60	1753.4	69.0	7	1515	3,339	∴
	K100	2.55	3.34	1676	66	1753.4	69.0	7	1602	3,532	∴
Heavy Duty	K110	0.74	0.97	762	30	1779.1	70.0	3	1070	2,358	●
	K110	0.95	1.24	914	36	1779.1	70.0	4	1216	2,682	●
	K110	1.18	1.54	1067	42	1779.1	70.0	4	1310	2,889	●
	K110	1.41	1.84	1219	48	1779.1	70.0	5	1441	3,178	●
	K110	1.64	2.15	1372	54	1779.1	70.0	5	1539	3,393	◐
	K110	1.87	2.45	1524	60	1779.1	70.0	6	1672	3,686	○
	K110	2.10	2.75	1676	66	1779.1	70.0	7	1805	3,979	∴
	K110	2.34	3.06	1829	72	1779.1	70.0	7	1904	4,197	∴
Heavy Duty Rock	K110	0.74	0.97	762	30	1779.1	70.0	3	1131	2,493	●
	K110	0.95	1.24	914	36	1779.1	70.0	4	1293	2,849	●
	K110	1.18	1.54	1067	42	1779.1	70.0	4	1400	3,086	●
	K110	1.41	1.84	1219	48	1779.1	70.0	5	1547	3,411	●
	K110	1.64	2.15	1372	54	1779.1	70.0	5	1660	3,659	○
Heavy Duty Power	K110	0.95	1.24	914	36	1681.8	66.2	4	1192	2,628	●
	K110	1.40	1.83	1219	48	1681.8	66.2	5	1421	3,132	●
	K110	1.63	2.13	1372	54	1681.8	66.2	5	1518	3,346	◐
	K110	1.86	2.43	1524	60	1681.8	66.2	6	1650	3,637	○
Ditch Cleaning	N/A	1.63	2.13	1524	60	1410.0	55.5	—	1088	2,399	◐
	N/A	1.91	2.50	1830	72	1410.0	55.5	—	1217	2,683	○

Assumptions for maximum material density rating:

1. Front linkage fully extended at ground line
2. Bucket curled
3. 100% bucket fill factor

* Based on SAE J296, some calculations of capacity specs fall on borderlines. Rounding may allow two buckets to have the same English rating, but different metric ratings.

- 2100 kg/m³ (3,500 lb/yd³) max material density
- ◐ 1800 kg/m³ (3,000 lb/yd³) max material density
- 1500 kg/m³ (2,500 lb/yd³) max material density
- ∴ 1200 kg/m³ (2,000 lb/yd³) max material density

324D L Work Tool Matching Guide

Boom Options	Reach Boom 5.9 m (19'4")			Mass Boom 5.3 m (17'5")
Stick Options	R3.6B1 (11'10")	R2.95CB1 (9'8")	R2.5CB1 (8'2")	M2.5DB (8'2")
Hydraulic Hammer	H120Cs/ H130s/ H140Ds	H120Cs/ H130s/ H140Ds	H120Cs/ H130s/ H140Ds	H120Cs/ H130s/ H140Ds
Multi-Processor	MP15/MP20	MP15/MP20 MP30	MP15/MP20	N/A N/A
360° Scrap Shear	S320	S320 S340	S320	S320 N/A
Mechanical Shear	S115	S115	S115	S115
Mechanical Pulverizer	P115	P120	P120	P120
Trash Grapple**	Available as field installed attachment only			
Contractors' Grapple**	Available as field installed attachment only			
Rotating Sorting/Demolition Grapple	G315	G315	G315	G315
Vibratory Plate Compactor	CVP110	CVP110	CVP110	CVP110
Hydraulic Thumb**	Available as field installed attachment only			
Dedicated Quick Coupler**	Available as field installed attachment only			
Pin-Grabber Quick Coupler	Available as factory or field installed attachment			N/A

* S325 only without PG Coupler.

** Contact Cat Work Tools for availability and proper matching.

Reach Boom Lift Capacities



Load Point Height



Load Radius Over Front



Load Radius Over Side



Load at Maximum Reach – Bucket Curled





Load at Maximum Reach – Bucket Extended

BOOM – 5.9 m (19'4")
R3.6B1 STICK – 3.6 m (11'10")

BUCKET – 1067 mm (42") HDP
with General Duty Tips
902 kg (1,989 lb)

SHOES – 800 mm (32") triple grouser
UNDERCARRIAGE – Long
HEAVY LIFT – On



	3.0 m (10.0 ft)		4.5 m (15.0 ft)		6.0 m (20.0 ft)		7.5 m (25.0 ft)		9.0 m (30.0 ft)									
	kg	lb	kg	lb	kg	lb	kg	lb	kg	lb	kg	lb	m	ft	kg	lb	m	ft
7.5 m 25 ft							*3630 *8,000	*3630 *8,000			*3260 *7,250	*3260 *7,250	7.65 24.8		*2810 *6,190	*2810 *6,190	7.49 24.6	
6.0 m 20 ft							*4770 *10,200	4410 9,450			*3130 *6,900	*3130 *6,900	8.59 28.0		*2580 *5,700	*2580 *5,700	8.82 28.6	
4.5 m 15 ft							*5390 *11,800	4320 9,250	*3720 *7,050	3010 6,400	*3140 *6,900	2880 6,400	9.18 30.1		*2510 *5,550	*2510 *5,550	9.66 31.6	
3.0 m 10 ft	kg lb	*13 090 *28,850	*13 090 *28,850	*8750 *18,850	*8750 *18,850	*6970 *15,100	6070 13,050	*6040 *13,150	4150 8,900	4710 *9,750	2950 6,300	*3270 *7,200	2630 5,800	9.5 31.2	*2540 *5,600	2440 5,400	10.16 33.3	
1.5 m 5 ft	kg lb	*7120 *17,050	*7120 *17,050	*11 340 *24,450	8950 19,250	*8310 *18,000	5690 12,250	6290 13,500	3950 8,500	4620 9,900	2860 6,100	*3530 *7,750	2530 5,600	9.58 31.4	*2650 *5,850	2270 5,000	10.38 34.1	
Ground Line	kg lb	*6530 *14,950	*6530 *14,950	*13 130 *28,400	8370 18,000	8760 18,800	5380 11,550	6100 13,100	3780 8,100	4530 9,700	2770 5,950	*3960 *8,700	2560 5,650	9.41 30.9	*2860 *6,300	2230 4,900	10.35 34.0	
-1.5 m -5 ft	kg lb	*9060 *20,600	*9060 *20,600	*13 830 *29,950	8100 17,400	8550 18,350	5190 11,150	5980 12,850	3670 7,900			4490 9,900	2740 6,050	8.99 29.5	*3200 *7,050	2300 5,100	10.05 33.0	
-3.0 m -10 ft	kg lb	*13 070 *29,700	*13 070 *29,700	*13 560 *29,350	8060 17,300	8480 18,200	5130 11,050	5950 12,800	3650 7,850			5130 11,350	3140 6,950	8.27 27.0	*3730 *8,250	2540 5,600	9.47 31.0	
-4.5 m -15 ft	kg lb	*16 150 *36,250	*16 150 *36,000	*12 220 *26,300	8190 17,600	8570 18,450	5220 11,250					6490 14,550	4000 8,950	7.17 23.3	*4670 *10,400	3050 6,750	8.54 27.9	

* Limited by hydraulic capacity rather than tipping load. The above loads are in compliance with SAE hydraulic excavator lift capacity rating standard J1097. They do not exceed 87% of hydraulic lifting capacity or 75% of tipping capacity. Weight of all lifting accessories must be deducted from the above lifting capacities.

BOOM – 5.9 m (19'4")
R2.95CB1 STICK – 2.95 m (9'8")

BUCKET – 914 mm (36") HD
with General Duty Tips
982 kg (2,165 lb)

SHOES – 800 mm (32") triple grouser
UNDERCARRIAGE – Long
HEAVY LIFT – On

	1.5 m (5.0 ft)		3.0 m (10.0 ft)		4.5 m (15.0 ft)		6.0 m (20.0 ft)		7.5 m (25.0 ft)									
	kg	lb	kg	lb	kg	lb	kg	lb	kg	lb	kg	lb	m	ft	kg	lb	m	ft
7.5 m 25 ft											*4130 *9,150	*4130 *9,150	6.94 22.4		*2990 *6,600	*2990 *6,600	8.26 26.8	
6.0 m 20 ft									*5270 *10,800	4220 9,000	*3920 *8,650	3710 8,300	7.96 26.0		*2900 *6,400	*2900 *6,400	9.19 30.0	
4.5 m 15 ft							*6490 *14,100	6220 13,350	*5920 *12,950	4170 8,950	*3930 *8,650	3160 7,000	8.6 28.1		*2940 *6,450	2620 5,800	9.74 31.9	
3.0 m 10 ft	kg lb			*10 050 *21,650	9470 20,400	*7690 *16,650	5920 12,750	6380 13,700	4040 8,650	*4090 *9,000	2870 6,350	8.94 29.3		*3070 *6,750	2430 5,350	9.98 32.7		
1.5 m 5 ft	kg lb			*12 400 *26,750	8760 18,850	*8910 *19,300	5600 12,050	6210 13,350	3880 8,350	*4430 *9,750	2770 6,100	9.02 29.6		*3310 *7,300	2390 5,250	9.94 32.6		
Ground Line	kg lb			*4830 *11,200	*4830 *11,200	*13 710 *29,650	8330 17,900	8730 18,750	5350 11,500	6070 13,050	3750 8,050	4620 10,200	2830 6,250	8.84 29.0	*3700 *8,150	2490 5,500	9.62 31.6	
-1.5 m -5 ft	kg lb	*5140 *11,550	*5140 *11,550	*8880 *20,250	*8880 *20,250	*13 930 *30,200	8180 17,600	8580 18,450	5220 11,250	5990 12,900	3680 7,900	5010 11,050	3070 6,800	8.39 27.5	*4340 *9,600	2790 6,150	9.0 29.5	
-3.0 m -10 ft	kg lb	*9620 *21,650	*9620 *21,650	*14 460 *32,950	*14 460 *32,950	*13 180 *28,500	8220 17,650	8580 18,450	5220 11,250	6020 13,270	3710 8,170	5880 13,050	3630 8,050	7.62 24.9	*3770 *8,200	3450 7,700	7.97 26.0	
-4.5 m -15 ft	kg lb			*15 780 *33,900	*15 780 *33,900	*11 200 *24,000	8430 18,150	*8000 *16,850	5380 11,600			*7120 *15,700	4880 11,000	6.41 20.8				

* Limited by hydraulic capacity rather than tipping load. The above loads are in compliance with SAE hydraulic excavator lift capacity rating standard J1097. They do not exceed 87% of hydraulic lifting capacity or 75% of tipping capacity. Weight of all lifting accessories must be deducted from the above lifting capacities.

Always refer to the appropriate Operation and Maintenance Manual for specific product information.

Reach Boom Lift Capacities



Load Point Height



Load Radius Over Front



Load Radius Over Side



















Load at Maximum Reach – Coupler Curled

BOOM – 5.9 m (19'4")
R2.95CB1 STICK – 2.95 m (9'8")

BUCKET – No Bucket
Bare Quick Coupler

SHOES – 800 mm (32") triple grouser
UNDERCARRIAGE – Long
HEAVY LIFT – On

	1.5 m (5.0 ft)		3.0 m (10.0 ft)		4.5 m (15.0 ft)		6.0 m (20.0 ft)		7.5 m (25.0 ft)		9.0 m (30.0 ft)				m ft	
																
7.5 m 25 ft	kg lb													*4590 *10,200	*4590 *10,200	6.97 22.5
6.0 m 20 ft	kg lb								*5690 *11,800	4570 9,800				*4340 *9,600	4060 9,050	7.99 26.0
4.5 m 15 ft	kg lb							*6800 *14,800	6490 13,950	*6280 *13,750	4480 9,650			*4290 *9,450	3500 7,750	8.62 28.2
3.0 m 10 ft	kg lb					*10 270 *22,100	9630 20,750	*7980 *17,300	6150 13,250	6660 14,300	4330 9,300			*4410 *9,700	3200 7,050	8.96 29.4
1.5 m 5 ft	kg lb					*12 630 *27,250	8920 19,200	*9190 19,800	5820 12,550	6470 13,950	4150 8,950	4850 10,690	3110 6,850	*4700 *10,350	3080 6,800	9.04 29.7
Ground Line	kg lb			*5290 *12,200	*5290 *12,200	*13 960 *30,200	8500 18,300	8930 19,200	5570 12,000	6320 13,600	4020 8,650			4910 10,800	3130 6,900	8.86 29.1
-1.5 m -5 ft	kg lb	*5450 *12,200	*5450 *12,200	*9350 *21,300	*9350 *21,300	*14 200 30,500	8360 17,950	8780 18,900	5440 11,700	6240 13,450	3950 8,500			5280 11,650	3350 7,400	8.41 27.6
-3.0 m -10 ft	kg lb	*10 000 *22,500	*10 000 *22,500	*14 960 *34,100	*14 960 *34,100	*13 450 *29,100	8390 18,050	8780 18,900	5440 11,750	6280 13,840	3980 8,770			6110 13,510	3880 8,600	7.64 25.0
-4.5 m -15 ft	kg lb			*16 030 *34,450	*16 030 *34,450	*11 480 *24,600	8590 18,500	*8310 *17,600	5590 12,100					*7390 *16,300	5090 11,400	6.44 20.9

* Limited by hydraulic capacity rather than tipping load. The above loads are in compliance with SAE hydraulic excavator lift capacity rating standard J1097. They do not exceed 87% of hydraulic lifting capacity or 75% of tipping capacity. Weight of all lifting accessories must be deducted from the above lifting capacities.



Load Point Height



Load Radius Over Front



Load Radius Over Side



Load at Maximum Reach – Bucket Curled

















Load at Maximum Reach – Bucket Extended

BOOM – 5.9 m (19'4")
R2.5CB1 STICK – 2.5 m (8'2")

BUCKET – 914 mm (36") HD
with General Duty Tips
982 kg (2,165 lb)

SHOES – 800 mm (32") triple grouser
UNDERCARRIAGE – Long
HEAVY LIFT – On

	3.0 m (10.0 ft)		4.5 m (15.0 ft)		6.0 m (20.0 ft)		7.5 m (25.0 ft)						m ft		
															
7.5 m 25 ft	kg lb				*6110 *13,650	*6110 13,400			*5830 *12,950	5540 12,600	6.4 20.6	*4060 *9,000	*4060 *9,000	7.73 25.0	
6.0 m 20 ft	kg lb				*6220 *13,600	*6220 13,550			*5500 *12,150	4130 9,250	7.49 24.4	*3950 *8,700	3320 7,400	8.74 28.5	
4.5 m 15 ft	kg lb			*8410 *18,100	*8410 *18,100	*7020 *15,250	6150 13,200	*6330 *13,850	4120 8,850	*5500 *12,100	3470 7,700	8.17 26.7	*3990 *8,800	2860 6,350	9.32 30.5
3.0 m 10 ft	kg lb			*10 880 *23,400	9280 20,000	*8170 *17,650	5860 12,600	6350 13,600	4010 8,600	5040 11,150	3140 6,950	8.53 28.0	*4170 *9,150	2640 5,850	9.57 31.4
1.5 m 5 ft	kg lb			*12 980 *28,000	8620 18,550	8950 19,250	5550 11,950	6200 13,300	3880 8,300	4900 10,800	3030 6,700	8.61 28.3	4210 9,250	2600 5,700	9.53 31.3
Ground Line	kg lb			*13 930 *30,150	8270 17,800	8710 18,700	5340 11,500	6080 13,050	3770 8,100	5030 11,100	3100 6,850	8.42 27.6	4420 9,750	2720 6,000	9.2 30.2
-1.5 m -5 ft	kg lb	*9100 *20,800	*9100 *20,800	*13 820 *29,950	8200 17,650	8610 18,500	5250 11,300	6030 13,000	3730 8,000	5510 12,150	3400 7,500	7.95 26.1	*4690 *10,300	3090 6,850	8.53 27.9
-3.0 m -10 ft	kg lb	*16 530 *37,800	*16 530 36,450	*12 750 *27,550	8300 17,850	8660 18,600	5290 11,400			6600 14,650	4090 9,100	7.13 23.3	*3340 *7,250	*3340 *7,250	7.43 24.2
-4.5 m -15 ft	kg lb	*14 110 *30,250	*14 110 *30,250	*10 260 *21,850	8580 18,500					*7340 *16,180	5790 *12,760	5.81 19.1			

* Limited by hydraulic capacity rather than tipping load. The above loads are in compliance with SAE hydraulic excavator lift capacity rating standard J1097. They do not exceed 87% of hydraulic lifting capacity or 75% of tipping capacity. Weight of all lifting accessories must be deducted from the above lifting capacities.

Always refer to the appropriate Operation and Maintenance Manual for specific product information.

Reach Boom Lift Capacities



Load Point Height



Load Radius Over Front



Load Radius Over Side



Load at Maximum Reach – Coupler Curled

BOOM – 5.9 m (19'4")
R2.5CB1 STICK – 2.5 m (8'2")

BUCKET – No Bucket
Bare Quick Coupler

SHOES – 800 mm (32") triple grouser
UNDERCARRIAGE – Long
HEAVY LIFT – On

	3.0 m (10.0 ft)		4.5 m (15.0 ft)		6.0 m (20.0 ft)		7.5 m (25.0 ft)				m ft	
7.5 m 25 ft	kg lb				*6530 *14,600	*6530 14,300			*6300 *14,000	5890 13,400	6.43 20.7	
6.0 m 20 ft	kg lb				*6580 *14,400	*6580 14,250	*6010 *13,240	4500 9,920	*5910 *13,050	4480 10,000	7.52 24.5	
4.5 m 15 ft	kg lb			*8640 *18,650	*8640 *18,650	*7330 *15,950	6410 13,800	*6700 14,600	4450 9,550	5830 *12,900	3800 8,450	8.19 26.8
3.0 m 10 ft	kg lb			*11 090 *23,850	9440 20,350	*8450 *18,300	6090 13,100	6630 14,250	4300 9,250	5350 11,800	3460 7,650	8.55 28.0
1.5 m 5 ft	kg lb			*13 230 *28,550	8790 18,950	9150 19,700	5780 12,450	6460 13,900	4150 8,950	5190 11,450	3330 7,350	8.63 28.3
Ground Line	kg lb			*14 200 *30,750	8460 18,200	8910 19,150	5560 12,000	6340 13,650	4030 8,700	5310 11,700	3390 7,470	8.45 27.7
-1.5 m -5 ft	kg lb	*9520 *21,750	*9520 *21,750	*14 100 30,550	8390 18,050	8810 18,950	5470 11,800	6290 13,550	3990 8,600	5760 12,750	3670 8,100	7.97 26.1
-3.0 m -10 ft	kg lb	*16 990 *38,850	*16 990 36,700	*13 030 *28,200	8470 18,200	8850 19,050	5510 11,900			6820 15,150	4330 9,600	7.15 23.4
-4.5 m -15 ft	kg lb	*14 370 *30,850	*14 370 *30,850	*10 540 *22,500	8730 18,800					*7590 *16,700	5960 13,450	5.84 18.9

* Limited by hydraulic capacity rather than tipping load. The above loads are in compliance with SAE hydraulic excavator lift capacity rating standard J1097. They do not exceed 87% of hydraulic lifting capacity or 75% of tipping capacity. Weight of all lifting accessories must be deducted from the above lifting capacities.

Always refer to the appropriate Operation and Maintenance Manual for specific product information.

Super Long Reach Boom Lift Capacities



Load Point Height



Load Radius Over Front



Load Radius Over Side





















Load at Maximum Reach - Bucket Curled

BOOM – 10.2 m (33'6")
STICK – 7.85 m (25'9")

BUCKET – 1142 mm (45")
Ditch Cleaning Bucket
291 kg (642 lb)

SHOES – 800 mm (32") triple grouser
UNDERCARRIAGE – Long
HEAVY LIFT – On

	6.0 m (20.0 ft)		7.5 m (25.0 ft)		9.0 m (30.0 ft)		10.5 m (35.0 ft)		12.0 m (40.0 ft)		13.5 m (45.0 ft)		15.0 m (50.0 ft)				m ft		
																			
12.0 m 40.0 ft	kg																*980	*980	15.24
	lb																*2,200	*2,200	49.56
10.5 m 35.0 ft	kg											*1630	*1630	*1710	*1710		*930	*930	16.16
	lb											*3,650	*3,650	*3,550	*3,550		*2,050	*2,050	52.72
9.0 m 30.0 ft	kg											*1610	*1610	*1680	*1680		*900	*900	16.89
	lb											*3,600	*3,600	*3,700	3,700		*2,000	*2,000	55.21
7.5 m 25.0 ft	kg											*1730	*1730	*1710	*1710		*870	*870	17.01
	lb											*3,750	*3,750	*3,800	3,650		*1,920	*1,920	57.11
6.0 m 20.0 ft	kg											*1820	*1820	*1790	1680		*870	*870	17.62
	lb											*4,000	*4,000	*3,900	3,550		*1,930	*1,930	58.32
4.5 m 15.0 ft	kg								*2070	*2070	*1960	*1960	*1890	1600		*880	*880	17.99	
	lb								*4,500	*4,500	*4,300	*4,300	*4,150	3,400		*1,940	*1,940	59.02	
3.0 m 10.0 ft	kg					*2860	*2860	*2530	*2530	*2300	*2300	*2130	1910	*2010	1510		*910	880	18.22
	lb					*6,200	*6,200	*5,500	*5,500	*5,000	*5,000	*4,650	4,100	*4,400	3,200		*2,002	1,940	59.76
1.5 m 5.0 ft	kg	*5290	*5290	*4060	*4060	*3330	*3330	*2860	2820	*2540	2230	*2300	1780	*2140	1420		*930	860	18.32
	lb	*11,400	*11,400	*8,750	*8,750	*7,200	*7,200	*6,200	6,050	*5,500	4,800	*5,000	3,800	*4,650	3,000		*2,050	1,900	59.91
Ground Line	kg	*6250	5670	*4690	4220	*3770	3260	*3180	2580	*2770	2060	*2480	1660	*2270	1330		*950	850	18.28
	lb	*13,500	12,250	*10,150	9,100	*8,150	7,050	*6,900	5,550	*6,000	4,400	*5,400	3,550	*4,950	2,850		*2,090	1,880	59.83
-1.5 m -5.0 ft	kg	*6950	5140	*5220	3830	*4160	2980	*3470	2370	*2990	1910	*2650	1550	2240	1260		*1000	860	18.12
	lb	*15,050	11,100	*11,300	8,250	*9,000	6,400	*7,500	5,100	*6,500	4,100	5,750	3,300	4,800	2,700		*2,200	1,900	59.58
-3.0 m -10.0 ft	kg	*7400	4820	*5600	3570	*4470	2770	*3710	2210	3090	1790	2580	1460	2180	1200		*1080	890	17.82
	lb	*16,050	10,400	*12,150	7,700	*9,700	5,950	*8,050	4,750	6,650	3,850	5,550	3,100	4,650	2,550		*2,380	1,960	58.40
-4.5 m -15.0 ft	kg	*7650	4670	*5850	3410	4550	2640	3650	2100	3000	1710	2520	1400	2140	1160		*1180	960	17.36
	lb	*16,550	10,050	*12,700	7,350	9,800	5,650	7,850	4,500	6,450	3,650	5,400	3,000	4,600	2,500		*2,600	2,060	56.90
-6.0 m -20.0 ft	kg	*7710	4630	5840	3340	4480	2570	3590	2040	2950	1660	2480	1370	2130	1150		*1310	1090	16.74
	lb	*16,700	9,950	12,550	7,200	9,650	5,500	7,700	4,400	6,350	3,550	5,350	2,950	4,600	2,450		*2,920	2,130	54.87
-7.5 m -25.0 ft	kg	*7600	4670	5850	3350	4460	2550	3570	2030	2950	1650	2490	1380	2160	1180		*1500	1230	15.94
	lb	*16,450	10,050	12,600	7,200	9,600	5,500	7,700	4,350	6,350	3,550	5,400	2,950				*3,310	2,710	52.22
-9.0 m -30.0 ft	kg	*7310	4800	*5780	3420	4510	2600	3610	2060	2990	1690	2550	1440				*1770	1480	14.92
	lb	*15,800	10,350	*12,450	7,350	9,750	5,600	7,800	4,450	6,450	3,650	5,550	3,150				*3,900	3,260	46.02
-10.5 m -35.0 ft	kg	*6800	4990	*5420	3550	*4430	2710	*3670	2160	*3010	1800						*2200	1870	13.63
	lb	*14,600	10,800	*11,600	7,700	*9,500	5,850	*7,800	4,700	*6,350	3,950						*4,850	4,190	44.77
-12.0 m -40.0 ft	kg	*5970	5280	*4780	3770	*3870	2890	*3090	2350								*2590	*1930	11.96
	lb	*12,650	11,450	*10,100	8,200	*8,150	6,300	*6,350	5,150								*5,710	4,310	38.77
-12.0 m -40.0 ft	kg	*4620	*4620	*3630	*3630	*2700	*2700												

* Limited by hydraulic capacity rather than tipping load. The above loads are in compliance with SAE hydraulic excavator lift capacity rating standard J1097. They do not exceed 87% of hydraulic lifting capacity or 75% of tipping capacity. Weight of all lifting accessories must be deducted from the above lifting capacities.

Always refer to the appropriate Operation and Maintenance Manual for specific product information.

Mass Boom Lift Capacities



Load Point Height



Load Radius Over Front



Load Radius Over Side



Load at Maximum Reach – Bucket Curled

















Load at Maximum Reach – Bucket Extended

BOOM – 5.3 m (17'5")
M2.5DB STICK – 2.5 m (8'2")

BUCKET – 1219 mm (48") HD
with General Duty Tips
1441 kg (3,177 lb)

SHOES – 800 mm (32") triple grouser
UNDERCARRIAGE – Long
HEAVY LIFT – On

	3.0 m (10.0 ft)		4.5 m (15.0 ft)		6.0 m (20.0 ft)		7.5 m (25.0 ft)								
											m	ft			m
7.5 m 25 ft	kg lb				*5600 *12,500	*5600 *12,400			*5350 *11,900	5040 11,500	6.42 20.7		*3610 *8,000	*3610 *8,000	7.81 25.3
6.0 m 20 ft	kg lb				*5740 *12,550	*5740 *12,550	*5110 *11,260	3680 8,110	*5040 *11,150	3660 8,200	7.51 24.5		*3490 *7,700	2880 6,450	8.81 28.8
4.5 m 15 ft	kg lb			*7980 *17,150	*7980 *17,150	*6550 *14,200	5760 12,350	*5840 *12,750	3700 7,900	5050 *11,150	3020 6,700	8.19 26.8	*3540 *7,800	2420 5,350	9.39 30.8
3.0 m 10 ft	kg lb			*10 420 *22,400	8920 19,200	*7700 *16,650	5470 11,750	5950 12,750	3600 7,700	4600 10,150	2700 5,950	8.54 28.0	*3710 *8,150	2200 4,850	9.64 31.6
1.5 m 5 ft	kg lb			*12 500 *26,950	8220 17,700	8570 18,400	5160 11,100	5800 12,450	3470 7,400	4460 9,850	2590 5,700	8.63 28.3	3760 8,300	2160 4,750	9.6 31.5
Ground Line	kg lb			*13 420 *29,050	7850 16,850	8320 17,850	4940 10,600	5680 12,200	3360 7,200	4600 10,150	2670 5,900	8.44 27.7	3960 8,750	2280 5,050	9.26 30.4
-1.5 m -5 ft	kg lb	*8390 *19,250	*8390 *19,250	*13 310 *28,850	7780 16,700	8220 17,650	4850 10,400	5640 12,100	3320 7,100	5090 11,250	2980 6,600	7.97 26.1	*4040 *8,850	2640 5,850	8.59 28.1
-3.0 m -10 ft	kg lb	*15 790 *36,150	*15 790 *35,400	*12 250 *26,450	7900 16,950	8270 17,750	4900 10,550			6190 13,750	3680 8,200	7.15 23.3	*2680 *5,800	*2680 *5,800	7.49 24.4
-4.5 m -15 ft	kg lb	*13 610 *29,150	*13 610 *29,150	*9780 *20,850	8200 17,650										

* Limited by hydraulic capacity rather than tipping load. The above loads are in compliance with SAE hydraulic excavator lift capacity rating standard J1097. They do not exceed 87% of hydraulic lifting capacity or 75% of tipping capacity. Weight of all lifting accessories must be deducted from the above lifting capacities.

Always refer to the appropriate Operation and Maintenance Manual for specific product information.

Standard Equipment

Standard equipment may vary. Consult your Caterpillar® dealer for details.

Electrical

- 65 Ampere alternator
- Base machine light (frame)
- Lights, cab mounted (Two)
- Horn
- Pre-start monitoring system – checks for low fluids (engine oil, coolant, hydraulic oil) prior to starting machine

Operator Environment

- Air conditioner, heater, defroster with automatic climate control
- AM/FM Radio with antenna and 2 speakers
- Ashtray with 24 volt lighter
- Beverage/cup holder
- Bolt-on Falling object Guarding System (FOGS) capability
- Cab Glass
 - Openable and retractable two-piece front windshield
 - Skylight, pop-up, polycarbonate
- Coat hook
- Floor mat
- Instrument panel and gauges
- Joysticks, console mounted, pilot operated
- Light, interior
- Literature compartment
- Monitor, full graphic color display
- Neutral lever (lock out) for all controls
- Polycarbonate side windows
- Positive filtered ventilation
- Pressurized cab
- Seat, suspension, with high back and head rest
- Seat belt, retractable – 76 mm (3 in)
- Storage compartment suitable for lunch box cooler
- Sun shade (for skylight)
- Travel control pedals with removable hand levers
- Windshield wiper and washer (upper and lower)

Engine/Power Train

- C7 with ACERT™ Technology
 - Air intake heater
 - Air-to-air aftercooler (ATAAC)
 - 24 volt electric start
 - Hydraulic electronic unit injectors (HEUI)
 - 2300 m (7,500 ft) altitude capability without derate
 - Automatic engine speed control with one touch low idle
- Cooling
 - Protection of 43° C (110° F) to –18° C (0° F) at 50% concentration
- Electric priming pump
- Straight line travel
- Two-speed auto-shift travel
- Water separator in fuel line
 - Water level indicator for water separator
- Undercarriage
 - Grease lubricated track
 - Hydraulic track adjusters
 - Idler and center section track guards
- Other Standard Equipment
 - Automatic swing parking brake
 - Auxiliary hydraulic valve
 - Capability of stackable valves (max of 3) for main valve
 - Capability of auxiliary circuit
 - Counterweight with lifting eyes
 - Door locks, cap locks and Caterpillar® one key security system
 - Fine swing control
 - Fully pressurized hydraulic system
 - Heavy lift
 - Mirrors (frame-right, cab left)
 - S•O•SSM quick sampling valves for engine and hydraulic oil
 - Travel alarm
 - Product Link PL321SR

Optional Equipment

Optional equipment may vary. Consult your Caterpillar® dealer for details.

Front Linkage

Booms

- Reach 5.9 m (19 ft 4 in)
- Mass 5.3 m (17 ft 5 in)
- Super Long Reach 10.2 m (33 ft 6 in)

Sticks

- Reach 3.6 m (11 ft 10 in)
- Reach 2.95 m (9 ft 8 in)
- Reach 2.5 m (8 ft 2 in)
- Mass 2.5 m (8 ft 2 in)

Bucket Linkage

- B1 Family
- CB1 Family
- DB Family

Boom Lowering Control Device

Electrical

- Machine Security System
- Power supply (12V-10 AMP)

Guarding

- Falling Object Guarding System (FOGS)
- Front windshield guard
 - Full length, wire mesh
- Heavy-duty bottom guards
- Rubber bumpers
- Track guiding guards
 - Sprocket end, idler end guard
 - Two-piece full length (center guard removed)
- Vandalism guards

Operator Environment

- Hand control pattern changer (ISO-SAE)
- Rear window, secondary exit
- Sunscreen – roller type
- Seat, high back with air suspension and heater
- Third pedal, straight travel

Engine/Power Train

- High ambient cooling
 - For conditions up to 52° C (125° F)
- Prefilter, air
- Starting, Cold weather package
 - Two additional maintenance free batteries
 - High capacity starter motor
 - Heavy-duty cable
 - Jump-start receptacle
 - Ether aid
 - Block heater

Undercarriage

- Track shoes
 - 600 mm (24 in) double grouser
 - 790 mm (31 in) triple grouser
 - 800 mm (32 in) Heavy-duty triple grouser
- Heavy-duty rollers

Auxiliary Hydraulics

- Hammer Circuit
 - For single function (1 way/2 pump) hydraulic tools
- Thumb Circuit
 - For double function (2 way/1 pump) hydraulic tools
- Tool Control System
 - For single or double function, (1 or 2 way, 1 or 2 pump) hydraulic tools
 - Joysticks with additional switches
 - Program up to 10 tools in memory
 - Capability of adding medium pressure
 - Medium pressure circuit for tools requiring medium pressure
- Hydraulic pin grabber quick coupler and controller
- Lines for booms and sticks

Work Tools

- Wide offering of buckets, tips and sidecutters

Notes

324D L Hydraulic Excavator

AEHQ5663-03 (2-09)

Replaces AEHQ5663-02

NACD, LACD

For more complete information on Cat products, dealer services,
and industry solutions, visit us on the web at www.cat.com

© 2009 Caterpillar
All Rights Reserved
Printed in U.S.A.

Materials and specifications are subject to change without notice.
Featured machines in photos may include additional equipment.
See your Caterpillar dealer for available options.

CAT, CATERPILLAR, ACERT, SAFETY.CAT.COM, their respective logos, "Caterpillar Yellow"
and the POWER EDGE trade dress, as well as corporate and product identity used
herein, are trademarks of Caterpillar and may not be used without permission.

CATERPILLAR[®]